

LUMINANCE METER

LS-100

LS-110

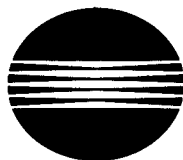





INSTRUCTION MANUAL





KONICA MINOLTA

SAFETY PRECAUTIONS

- To ensure correct use of this instrument read the following points carefully and adhere to them. After you have read this manual, keep it in a safe place where it can be referred to anytime a question arises.

 WARNING (Failure to adhere to the following points may result in death or serious injury.)	
 Do not use the instrument in places where flammable or combustible gases (gasoline etc.) are present. Doing so may cause a fire.	 Do not disassemble or modify the instrument. Doing so may cause a fire or electric shock.
 Do not dispose of batteries in fire, short their terminals, apply heat to them, or disassemble them. Also, do not recharge them. Doing so may cause explosion or heat generation, resulting in fire or injury.	 Take special care not to allow liquid or metal objects to enter the instrument. Doing so may cause a fire or electric shock. Should liquid or metal objects enter the instrument, turn the power OFF immediately, remove the batteries, and contact the nearest authorized service facility.
 Never aim the instrument directly at the sun and look through the viewfinder. Doing so can damage your eyes and the instrument.	

 CAUTION (Failing to adhere to the following points may result in injury or damage to the instrument or other property.)	
 Do not walk while looking through the viewfinder. Doing so may cause you to trip or bump something.	 Do not use batteries other than those specified by Minolta. When installing batteries in the instrument, make sure that they are correctly oriented according to the (+) and (-) marks. Failure to adhere to these instructions may cause explosion of the batteries or leakage of electrolyte, resulting in fire, injury or air pollution.

Safety Symbols

The following symbols are used in this manual to prevent accidents which may occur as result of incorrect use of the instrument.



Denotes a sentence regarding safety warning or note.
Read the sentence carefully to ensure safe and correct use.



Denotes a prohibited operation.
The operation must never be performed.



Denotes an instruction.
The instruction must be strictly adhered to.



Denotes a prohibited operation.
Never disassemble the instrument.

Luminance Meters LS-100 and LS-110 are lightweight, compact meters for taking luminance measurements of light sources or reflective surfaces. Using advanced optics and electronics, these meters are extremely accurate, completely portable, and easy to operate.

The LS-100 has a 1° acceptance angle; the LS-110 has a 1/3° acceptance angle. Both have a TTL (through-the-lens) viewing system which accurately indicates the area to be measured, and an in-viewfinder display to allow measurements to be seen along with the measurement subject. The optical system reduces flare, so that measurements are virtually unaffected by light sources outside the indicated measurement area. The silicon photocell measures light received by the lens, and is filtered to closely match the CIE Relative Photopic Luminosity Response. The signal from the sensor is processed by the built-in microcomputer, and measured values are displayed in 4 digits in both the external display and the viewfinder display.

The meters can measure over a wide range of luminance levels (LS-100: 0.001 to 299900 cd/m²; LS-110: 0.01 to 999900cd/m²). Absolute luminance can be measured in both cd/m² and fL; percent luminance can also be measured to compare the luminances of two subjects. Either of two calibration standards can be used for measurements: **PRESET** for measurements based on Factory calibration standard; **VARI.** for measurements based on a user-selected standard. The peak measurement taken while the trigger was held in can be displayed, and a color-correction factor can be used to automatically adjust the response of the meter when measuring colored subjects or using close-up lenses to measure small subjects. In addition, the LS-100 and LS-110 have digital data-output terminals for sending data to the Data Printer DP-10 or a separate computer.

Please read and study this manual before using the Luminance Meter LS-100 or LS-110 for the first time, and keep it for future reference.

STATEMENT OF FCC COMPLIANCE

This device complies with Part 15 of FCC Rules. Operation is subject to the following two conditions: (1)This device may not cause harmful interference, and (2)this device must accept any interference received, including interference that may cause undesired operation. Change or modifications not approved by the party responsible for compliance could void the user's authority to operate the equipment. This equipment has been tested and found to comply with the limits for a Class B digital device, pursuant to Part 15 of the FCC Rules. These limits are designed to provide reasonable protection against harmful interference in a residential installation. This equipment generates, uses and can radiate radio frequency energy and, if not installed and use in accordance with the instructions, may cause harmful interference to radio communication. However, there is no guarantee that interference will not occur in a particular installation. If this equipment does not cause harmful interference to radio or television reception, which can be determined by turning the equipment off and on, the user is encouraged to try to correct the interference by one or more of the following measures: Reorient or relocate the receiving antenna.

Increase the separation between the equipment and receiver.

Connect the equipment into an outlet on a circuit different from that to which the receiver is connected. Consult the dealer or an experienced radio/TV technician for help.

CONTENTS

	Page
DESCRIPTION	1
CONTENTS	2
NAMES OF PARTS	3
FUNCTIONS OF KEYS AND SWITCHES	4
DISPLAYS AND INDICATIONS	6
OPERATION FLOW CHART	10
PREPARATION	11
Installing battery	11
Selecting luminance unit	11
Eyepiece adjustment	12
NOTES ON USING THE LS-100/LS-110	13
CALIBRATION	14
PRESET calibration	14
VARI calibration	14
Standardizing meters	18
ABSOLUTE MEASUREMENTS	19
PERCENT LUMINANCE MEASUREMENTS	20
Input of reference luminance	20
Reference luminance data recall	24
Taking measurements	24
PEAK MEASUREMENTS	26
COLOR-CORRECTION FACTOR	27
Setting color-correction factor	27
Color-correction factor recall	29
Approximate color-correction factors of common light sources	30
Measurements using the color-correction factor	31
USING CLOSE-UP LENSES	32
MEMORY	33
Memory error	33
Clearing memory	33
LOCKING THE FOCUSING RING	34
MEASURING SYSTEM	35
Optical system	35
Electronic system	36
Influence of flare	36
KONICA MINOLTA STANDARD CALIBRATION PROCEDURE	37
CARE AND STORAGE	38
SPECIFICATIONS	39

NAMES OF PARTS

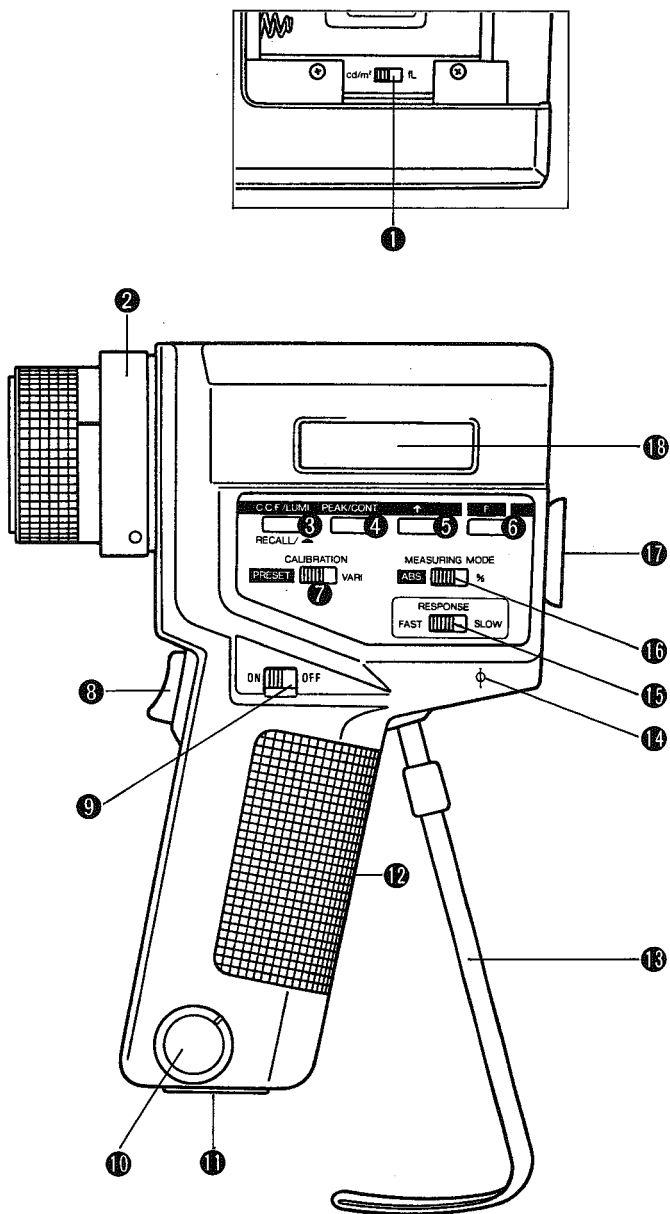

- | | |
|----------------------------------|----------------------------------|
| ① Luminance-unit selector switch | ⑩ Data-output terminal |
| ② Distance scale | ⑪ Tripod socket |
| ③ Data-control key | ⑫ Handgrip |
| ④ PEAK/CONT. key | ⑬ Wrist strap |
| ⑤ Increase key | ⑭ Focal-plane indication |
| ⑥ \square key | ⑮ RESPONSE speed selector switch |
| ⑦ CALIBRATION selector switch | ⑯ MEASURING MODE selector switch |
| ⑧ Measuring trigger | ⑰ Eyepiece |
| ⑨ Power switch | ⑱ External display |

FUNCTION OF KEYS AND SWITCHES

Luminance-unit selector switch

—Selects either cd/m^2 or fL luminance units

Data-control key (will be shown as throughout this manual.)

—Recalls user's calibration data from memory when MEASURING MODE selector switch is at **ABS.**, CALIBRATION selector switch is at **VARI.**, and data-control mode is set to "LUMI."

—Recalls reference luminance data from memory when MEASURING MODE selector switch is at % and CALIBRATION selector switch is at **PRESET** or **VARI.**

—Recalls color-correction factor from memory when MEASURING MODE selector switch is at **ABS.**, CALIBRATION selector switch is at **VARI.**, and data-control mode is set to "C.C.F."

—Selects data-control mode when pressed while held in.

Mode changes in the following order:

LUMI.→C.C.F.→C.C.F./LUMI.→LUMI....

—Moves cursor to select data to be changed when setting user's calibration data, reference luminance data, or C.C.F. value.

Data to be changed selected in the following order:

Recalled data→multiplier/decimal point→first digit (from left)→second digit→third digit→fourth digit→recalled data→...

PEAK/CONT key (will be shown as throughout this manual.)

—Changes data-display mode from **CONT** to **PEAK** or from **PEAK** to **CONT** when pressed while held in.

Increase key

—Increases the value of the digit above the cursor by one each time key is pressed while held in; number increases continuously if key is held down. Number can be set between 0 and 9; if key pressed after 9 is reached, number returns to 0 and cycle starts over.

key

—Releases the built-in safety lock which prevents data from being changed accidentally. Must be held down while pressing , , and to perform their designated functions.

—Stores user's calibration data in memory when held down while sliding CALIBRATION selector switch from **VARI** to **PRESET** and back to **VARI**.

—Stores reference luminance data for percent measurements when held down while sliding MEASURING MODE selector switch from **ABS.** to % (if reference data measured) or from % to **ABS.** to % (if reference data set using and .

—Stores color-correction factor in memory when held down while sliding CALIBRATION selector switch from **VARI** to **PRESET** and back to **VARI** with data-control mode set to "C.C.F."

CALIBRATION selector switch

—Selects the calibration standard: **PRESET** for Minolta standard, **VARI.** for user-selected calibration standard or for using color-correction factor.

—Stores user-selected calibration data in memory when slid from **VARI.** to **PRESET** and back to **VARI.** while held down.

—Stores color-correction factor in memory when slid from **VARI.** to **PRESET** and back to **VARI.** while held down with data-control mode set to "C.C.F."

MEASUREMENT MODE selector switch

- Selects measurement mode: **ABS.** for absolute luminance measurements, **%** for percent luminance measurements
- Stores reference luminance in memory when slid from **ABS.** to **%** (if reference luminance is measured) or from **%** to **ABS.** and back to **%** (if reference luminance is set) while **F** held down .

RESPONSE speed selector switch

- Selects meter's response speed.
- Set to **FAST** when metering under normal lighting conditions, including natural light, tungsten lighting, and fluorescent lighting.
- Set to **SLOW** when metering flickering light sources, including television screens, video monitors and projectors, movie projectors, flashing LED lighting, and non-continuous light sources.

Power switch

- Switches meter power **ON** and **OFF**.

Measuring trigger

- Takes measurement when pulled in; measurements are continuously made while trigger is held in.

DISPLAYS AND INDICATIONS

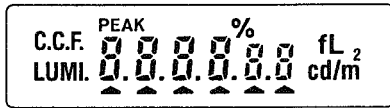

External display

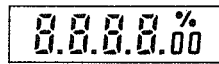

Viewfinder display

NOTE:

- The external display will be blank except for metering-mode information ("C.C.F.", "LUMI.", "PEAK", "%", and "cd/m²" or "fL") when the power switch is first slid to **ON** or when the measuring trigger is released before measurement has been completed.
- The viewfinder display will be off when the power switch is first slid to **ON**. It will remain off until the measuring trigger is pulled and is automatically turned off again about 5 seconds after measuring trigger is released.

Absolute luminance

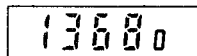
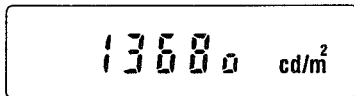

NOTE:

- The meter can measure luminance in both fL (foot-Lamberts) and cd/m² (candles per square meter). Sample displays will use cd/m² throughout this manual.

Peak absolute luminance

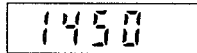
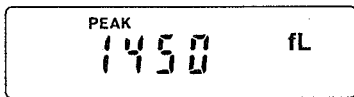

Luminance based on color-correction factor

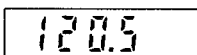
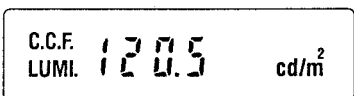
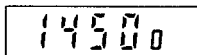
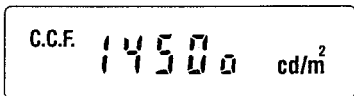

Percent luminance

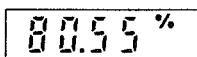
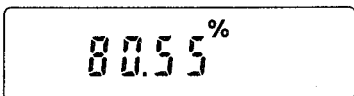

Peak percent luminance

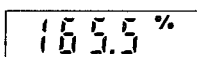
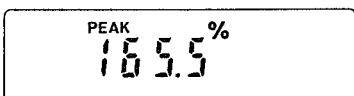

Data recall

VARI. calibration



Reference luminance

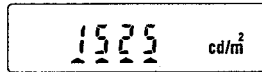

Color-correction factor

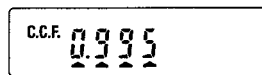

Battery power low

Battery power is almost exhausted. Replace battery.

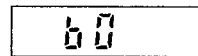
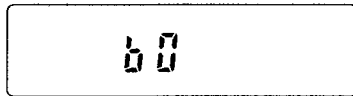

- If battery power is completely exhausted, no display will appear.

Calculations in progress

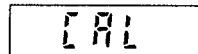
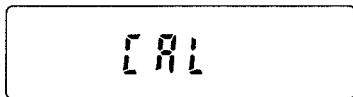

Appears for a short time when:

Measurements are converted between continuous and peak measurements;

Measurements are recalculated after changing data-control mode; or

When user-calibration data, reference luminance data, or color-correction factor is stored in memory.

Clear-memory-confirmation prompt

(See p. 33 for details.)

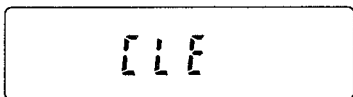

Error



Appears for a short time if:

Recalculation is attempted before measurement is taken.

An attempt is made to store 0 or E0 as user-calibration data, reference luminance data, or color-correction factor. Previous data will remain in memory.

User calibration is attempted without measurement. Previous data will remain in memory.

Over measuring range

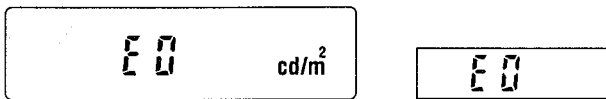

Appears when luminance exceeds measuring range.

LS-100: luminance over 299,900 cd/m^2 (87,540 fL) at **FAST** response speed, over 49,990 cd/m^2 (14,590 fL) at **SLOW** response speed

LS-110: luminance over 999,900 cd/m^2 (291,800 fL) at **FAST** response speed, over 499,900 cd/m^2 (145,900 fL) at **SLOW** response speed

Memory error



Stored user-calibration data, reference luminance data, or color-correction factor has been lost from memory. The memory must be cleared before proceeding (see p. 33).

Unit malfunction



The meter is malfunctioning and needs to be repaired. Contact the nearest Minolta Authorized Service Center.

Over display range

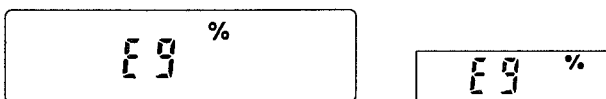

Present measurement would result in an absolute luminance value of over 999900 (cd/m^2 or fL) or a percent luminance value of over 999.9%. Check reference luminance value and take another measurement.

No reference luminance data in memory

E %

E %

Reference luminance data was not previously stored in memory. Measure or set data of reference luminance before proceeding.

- - -

Appears while keys are held down when changing data-control or PEAK/CONT. mode.

OPERATION FLOW CHART

Preparation

Insert battery.

Eyepiece adjustment

Set luminance unit.

Calibration

Minolta standard (PRESET)

User standard (VARI)

Measurement

Absolute measurements

Take measurements.

Percent luminance measurements

Input reference luminance

Take measurements.

PREPARATION

Installing battery

The meter is powered by a single 9V battery (Eveready 216 or equivalent).

1. Check that the power switch is at **OFF**.
2. Remove the battery-chamber cover by pressing down on it and pushing in the direction of the arrow on the cover.

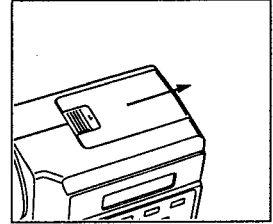

3. Position the battery terminals as shown inside the battery chamber, then insert the battery, terminal end first.

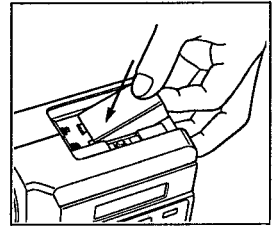

4. Replace the cover by realigning it and pushing towards the meter body until the cover snaps securely in place.

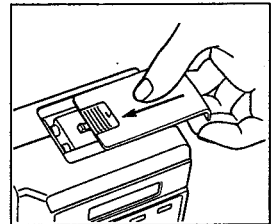

5. Slide the power switch to ON. If metering-mode information appears in the external display, the battery is OK. If "b0" or no display appears, battery power is exhausted. Replace with a new battery.

The meter may also be used with an external supply connected to the data-output terminal. See page 35 for required connections.

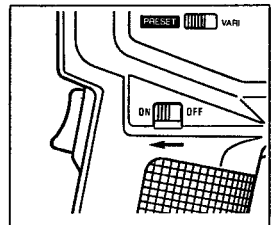

Selecting luminance unit

The meter can be used to measure luminance in cd/m^2 or fL. Select the desired measuring unit by following the steps below.

1. Remove the battery-chamber cover by pressing down on it and pushing in the direction of the arrow on the cover.

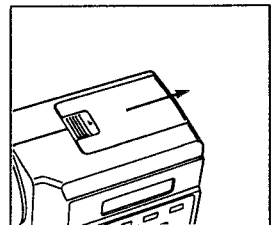

2. Adjust the luminance-unit selector switch to the desired setting.

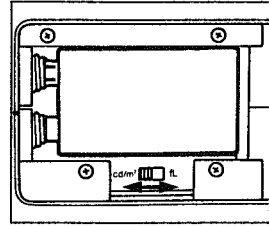

3. Replace the cover by realigning it and pushing towards the meter body until the cover snaps securely in place.

Measurements can be converted from one luminance unit to the other by sliding the luminance-unit selector switch to the desired position after measurement. The meter will automatically recalculate the last measurement and will also recalculate the user-calibration and reference luminance data in memory.

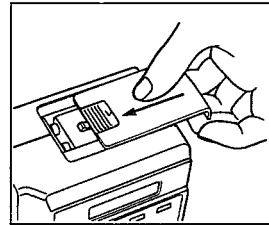

Eyepiece adjustment

Turn the eyepiece frame until the 1° ($1/3^\circ$ for LS-110) measurement-area indication is sharp in the viewfinder (adjustable diopter range: +2.5 to -3.75).

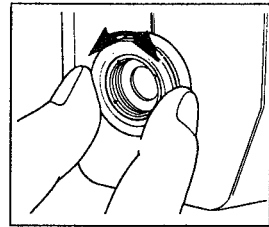

NOTES ON USING THE LS-100/LS-110

- When taking measurements, be sure that the subject fills the measurement area. If subject does not fill the measurement area, move closer or use a close-up lens and refocus. Measurements of subjects smaller than the measurement area will not be accurate.
- Metering-mode information ("C.C.F.", "LUMI.", "PEAK", "%", and "cd/m²" or "fL") will appear and measured values will not be displayed if the measuring trigger is released before measurement has been completed.
- New measurements will be taken and the readings displayed every 0.8 to 1 second at **FAST** response speed (every 1.4 to 1.6 seconds at **SLOW** response speed) if the measuring trigger is held in.
- While a measurement is shown in the LCD panel, it can be converted to a measurement in another mode by doing any of the following:
 - To convert to a peak measurement, press and hold **F** and press **P/C**. "PEAK" will appear in the display. See page 26.
 - To convert from an absolute luminance measurement to a percent luminance measurement (if a reference luminance has been previously stored in memory), slide the MEASURING MODE selector switch to **%**. See page 20.
 - To convert from a percent luminance measurement to an absolute luminance measurement, slide the MEASURING MODE selector switch to **ABS**. See page 19.
 - To convert to a measurement based on the other calibration value, slide the CALIBRATION selector switch to the other position. See page 14.
 - To convert to a measurement calculated to include the C.C.F., set CALIBRATION selector switch to **VARI.**, press and hold **F**, and press **RCL/▲** until "C.C.F." ("C.C.F." and "LUMI" if using **VARI.** calibration) appears in the display. See page 27.
 - To convert to a measurement in the other luminance unit, slide the luminance-unit selector switch to the other position. See page 11.
- When the position of the luminance-unit selector switch is changed, the meter will automatically recalculate the last measurement and will also recalculate the user-calibration and reference luminance data in memory.
- User's calibration data, reference luminance data, and color-correction factor are retained in memory until changed or cleared by the user. Data remains in memory even when the power is switched **OFF**, the battery is replaced, or the power cord is disconnected during use with an external power source.
- The viewfinder display will automatically turn off approximately 5 seconds after the trigger is released.
- If the meter is mounted on a tripod for extended metering and there is a bright light source near the viewfinder, meter readings may be affected by this light source. Cover the eyepiece with the included eyepiece cap whenever measurements will be taken while not looking through the viewfinder.
- The viewfinder display may be difficult to read when measuring extremely bright subjects. In such cases, insert the provided neutral-density (ND) filter into the eyepiece.
- If the LS-100/LS-110 is being used to measure a CRT, do not place the meter closer than 8 inches (20cm) from the CRT (as measured from the focal-plane indication).

CALIBRATION

PRESET calibration

The **PRESET** position of the CALIBRATION selector switch can be used when measuring most subjects. This position automatically calibrates the meter to the Minolta standard (see page 41 for details). It is not necessary for the user to calibrate the meter when the CALIBRATION selector switch is at **PRESET**.

VARI. calibration

The **VARI.** position allows the user to calibrate the meter to any subject desired. It can be used to calibrate the meter to another standard subject for which the luminance is known, to precisely standardize meters to the same subject, or when using a color-correction factor (see page 27). To use the **VARI.** position of the CALIBRATION selector switch, follow the steps below.

MEASURING USER-SELECTED STANDARD SUBJECT

1. Slide the POWER switch to **ON**.

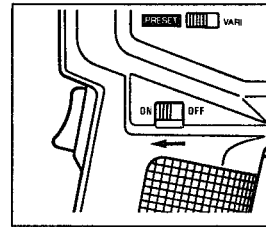

2. Set the CALIBRATION selector switch to **PRESET** and the MEASURING MODE selector switch to **ABS**. Check that RESPONSE speed and luminance-unit selector switches are in the desired position.

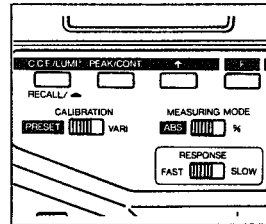

3. Aim the meter at standard subject and turn focusing ring until the subject appears sharp.

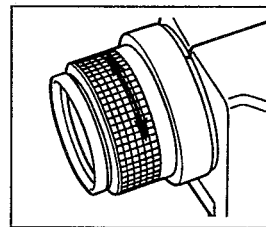

4. Pull the measuring trigger and hold it in until the luminance value appears in the viewfinder display (approximately 2 seconds at **FAST** response speed or 4 seconds at **SLOW** response speed). The luminance value will also appear in the external display, as shown at right.

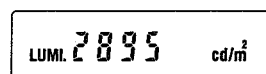
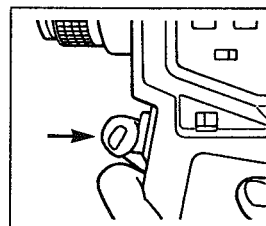

SETTING CALIBRATION DATA

Set **VARI.** calibration data of LS-100/LS-110 to the standard calibration data for the subject measured in step 4 according to the following steps.

5. Slide **CALIBRATION** selector switch from **PRESET** to **VARI.**

If "C.C.F." appears in the display, meter is set for measurements with a color-correction factor. Press and hold **F** and press **RCL/Δ** until only "LUMI" appears in the display.

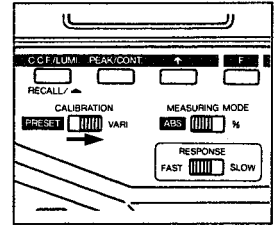

6. Press **RCL/Δ**. Previously set calibration data will appear in the external display, as shown at right. If no calibration data was previously set, the displayed value will be "0.000" ("00.00" for LS-110).

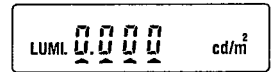
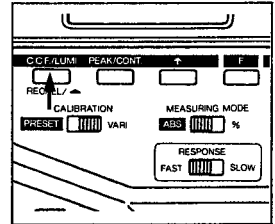

7. Press **RCL/Δ** again. Cursors will appear only under the multiplier positions, as shown at right.

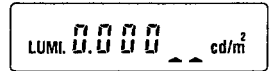
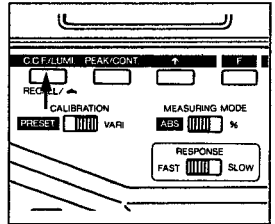

8. Set decimal-point position or multiplier if necessary by pressing and holding **F** and pressing **↑**. Decimal-point position and multiplier will change as shown below each time **↑** is pressed while **F** held down.

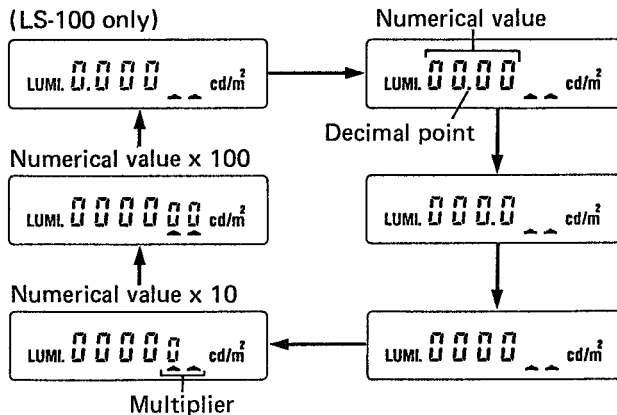
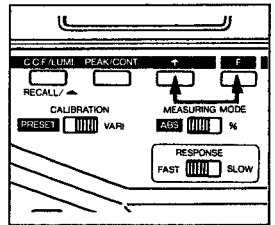

9. Press **RCL** again. The cursor will move to the first digit (from left) of the numerical value, as shown at right.

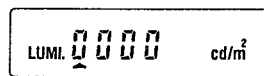
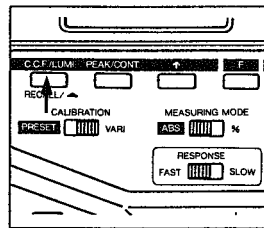

10. Set calibration data of first digit by pressing and holding **F** and pressing **↑**. The value of digit can be set between 0 and 9. The value is increased by one each time **↑** is pressed while **F** held down; increases continuously if both keys held down. When the value reaches 9, it will return to 0 if **↑** pressed while **F** held down.

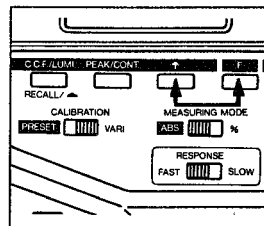

11. Press **RCL** again. The cursor will move one digit to the right.

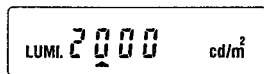
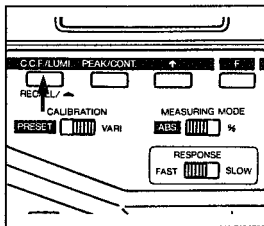

12. Set calibration data of digit by pressing and holding **F** and pressing **↑**.

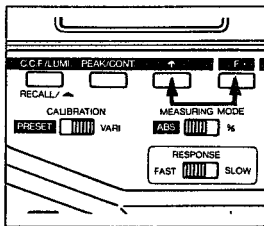

13. Repeat steps 11 and 12 to set third digit, and again to set fourth digit of calibration data.

STORING CALIBRATION DATA

- To store the calibration data in memory, press and hold **F** and slide the CALIBRATION selector switch from **VARI.** to **PRESET** and back to **VARI.** The external display will show "CAL" for a moment as the calibration data is stored, and then it will change to a measurement display showing the stored calibration data.

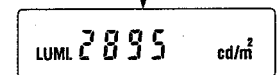
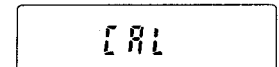
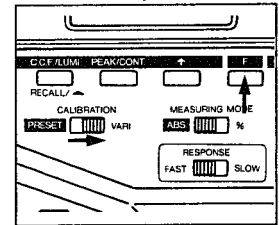
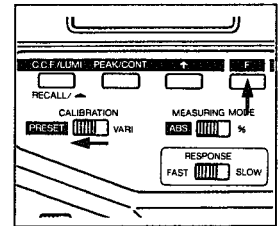

VARI. CALIBRATION DATA RECALL

To check user's calibration in memory:

- Slide the POWER switch to **ON**.
- Set the CALIBRATION selector switch to **VARI.** and the MEASURING MODE selector switch to **ABS.**
If "C.C.F." appears in the display, meter is set for measurements with a color-correction factor. Press and hold **F** and press **RCL** until only "LUMI" appears in the display.

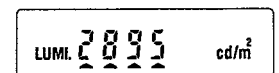
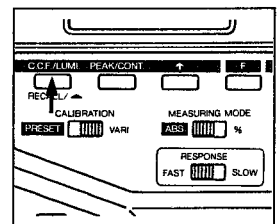
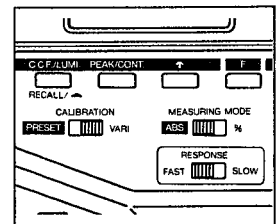
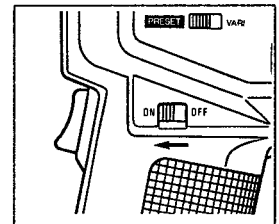

- Press **RCL**. The previously stored user's calibration data will appear in the external display, as shown at right. Cursors will appear under all four digits of the numerical value.

Recall display can be canceled by pressing measuring trigger or any of the operation keys, by changing the position of MEASURING MODE or CALIBRATION selector switch, or by sliding the POWER switch to **OFF**.

Standardizing meters

To standardize several meters, calibrate all meters to the same subject. Measure the subject with all meters, and set them to the standard calibration data for that subject following the procedures in the preceding **VARI. calibration** section.

ABSOLUTE MEASUREMENTS

Luminance Meter LS-100/LS-110 can be used to measure the luminance of a wide variety of light sources and reflective surfaces by following the steps below.

1. Slide power switch to **ON**.

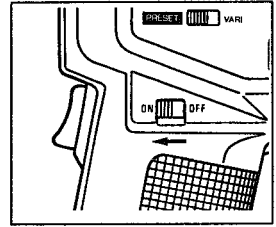

2. Set the MEASURING MODE selector switch to **ABS.** and check that CALIBRATION, RESPONSE speed, and luminance-unit selector switches are set to the desired positions.

If "PEAK" appears in the display, meter is set to peak mode.

To set meter to continuous mode, press and hold **F** and press **P/C**; "PEAK" will be removed from the display.

If "C.C.F." appears in the display, meter is set for measurements with a color-correction factor. Press and hold **F** and press **RCL** until only "LUMI" appears in the display.

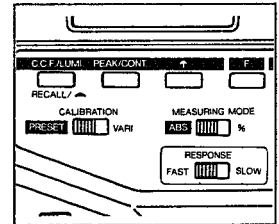

3. Aim the LS-100/LS-110 at the subject and turn the focusing ring until the subject appears sharp.

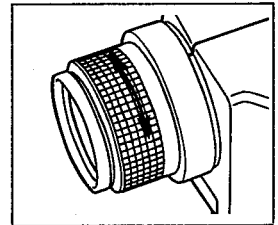

4. Pull the measuring trigger and hold it in until the luminance value appears in the viewfinder display (approximately 2 seconds at **FAST** response speed or 4 seconds at **SLOW** response speed). The luminance value will also be shown in the external display.

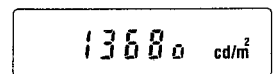
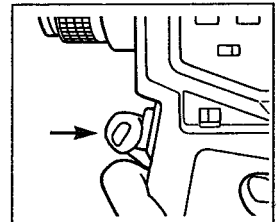

PERCENT LUMINANCE MEASUREMENTS

The LS-100/LS-110 can also be used to take percent luminance measurements for comparing the brightness of two light sources. Before taking percent luminance measurements, a reference luminance must first be stored in memory.

Input of reference luminance

1. Slide power switch to **ON**.

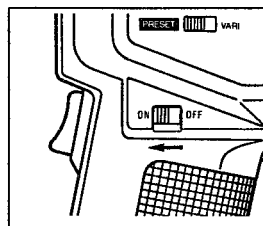

2. Check that **CALIBRATION**, **RESPONSE** speed, and luminance-unit selector switches are set to the desired positions.

If "PEAK" appears in the display, meter is set to peak mode. To set meter to continuous mode, press and hold **F** and press **P/C**; "PEAK" will be removed from the display.

If "C.C.F." appears in the display, meter is set for measurements with a color-correction factor. Press and hold **F** and press **RCL** until only "LUMI" appears in the display.

The reference luminance may be measured or set directly. If a suitable reference subject is available, start with step 3 below. If the reference luminance is known and no suitable subject is available, set **MEASURING MODE** selector switch to % and start with step 7 below.

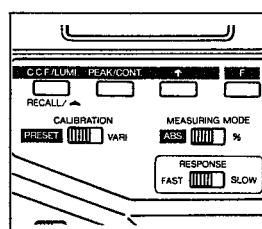

MEASURING REFERENCE SUBJECT

3. Set the MEASURING MODE selector switch to **ABS**.

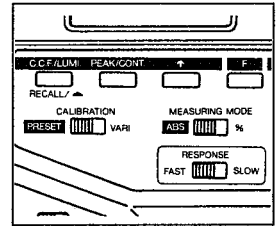

4. Aim the LS-100/LS-110 at the subject and turn the focusing ring until the subject appears sharp.

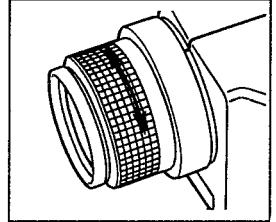

5. Pull the measuring trigger and hold it in until the luminance value appears in the viewfinder display (approximately 2 seconds at **FAST** response speed or 4 seconds at **SLOW** response speed). The luminance value will also be shown in the external display.

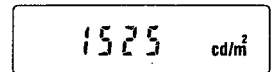
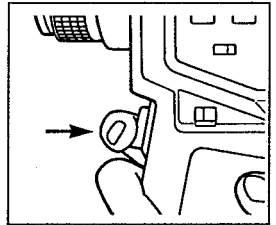

6. Press and hold **F** and slide the MEASURING MODE selector switch to **%**. The display will read "CAL" for a moment while the luminance value is stored in memory, and then will read "100%" to show that the value has been correctly memorized.

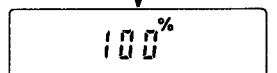
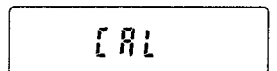
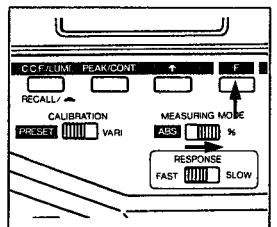

The LS-100/LS-110 is now ready to take percent luminance measurements based on the measured reference subject. If it is necessary to adjust these values, continue with step 7 below.

SETTING REFERENCE LUMINANCE DATA

7. Press **RCL**. Previously set reference luminance data will appear in the external display, as shown at right. If no reference luminance data was previously set, the displayed value will be "0.000" ("00.00" for LS-110).

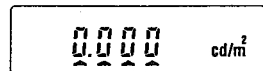
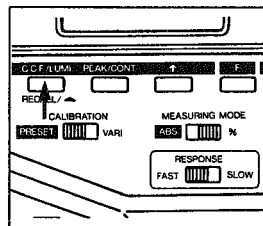

8. Press **RCL** again. Cursors will appear only under the multiplier positions, as shown at right.

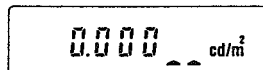
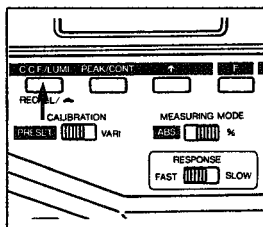

9. Set decimal-point position or multiplier if necessary by pressing and holding **F** and pressing **↑**. Decimal-point position and multiplier will change as shown below each time **↑** is pressed while **F** held down.

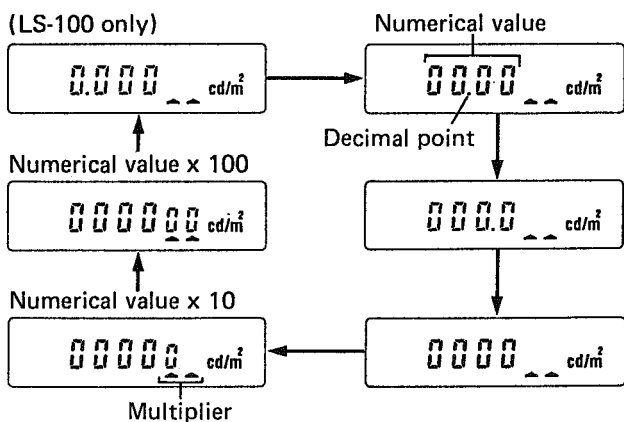
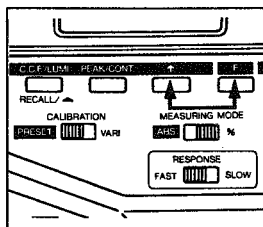

10. Press **RCL** again. The cursor will move to the first digit (from left) of the numerical value, as shown at right.

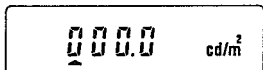
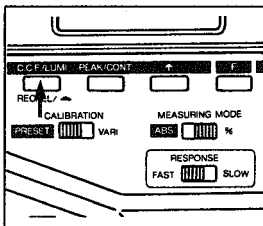

- Set reference luminance data of first digit by pressing and holding **F** and pressing **↑**.

The value of digit can be set between 0 and 9. The value is increased by one each time **↑** is pressed while **F** held down; increases continuously if both keys held down. When the value reaches 9, it will return to 0 if **↑** pressed while **F** held down.

- Press **RCL/Δ** again. The cursor will move one digit to the right.

- Set reference luminance data of digit by pressing and holding **F** and pressing **↑**.

- Repeat steps 12 and 13 to set third digit, and again to set fourth digit of reference luminance data.

- To store this data in memory, press and hold **F**, slide MEASURING MODE selector switch from % to **ABS**, and then back to %. The display will read "CAL" for a moment while the reference luminance data is stored in memory, and then will revert to the measurement display.

The LS-100/LS-110 is now ready to take percent luminance measurements based on the reference luminance data in memory.

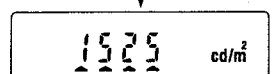
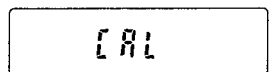
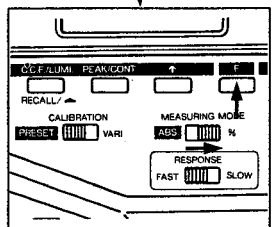
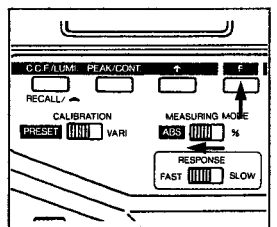
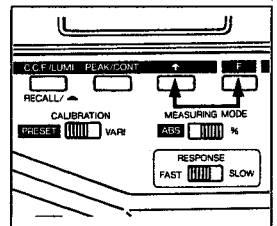
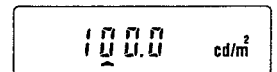
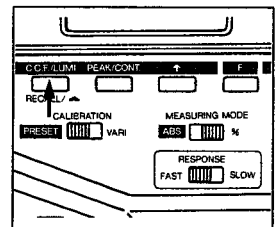
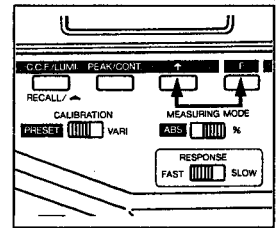

Reference luminance data recall

To check the reference luminance data in memory:

1. Slide power switch to **ON**.

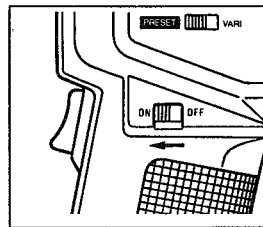

2. Set MEASURING MODE selector switch to **%** and CALIBRATION selector switch to the position which was set when reference luminance data was stored.

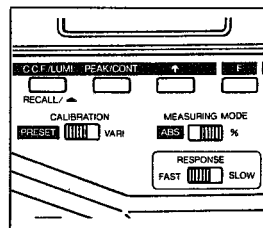

3. Press **RCLA**. The previously set reference luminance data will appear in the external display, as shown at right. Cursors will appear under all four digits of the numerical value.

Recall display can be canceled by pressing measuring trigger or any of the operation keys, by changing the position of MEASURING MODE or CALIBRATION selector switch, or by sliding the POWER switch to **OFF**.

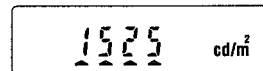
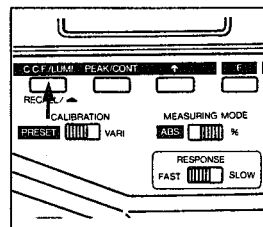

Taking measurements

1. Slide power switch to **ON**.

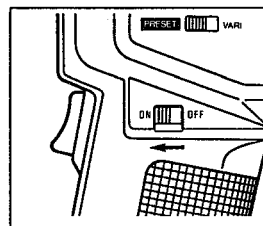

2. Set the MEASURING MODE selector switch to **%** and check that CALIBRATION, RESPONSE speed, and luminance-unit selector switches are set to the desired positions.

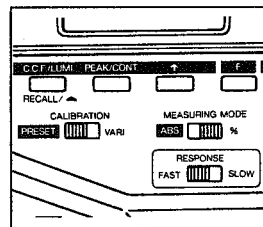

If "PEAK" appears in the display, meter is set to peak mode.

To set meter to continuous mode, press and hold **F** and press **P/C**; "PEAK" will be removed from the display.

3. Aim the LS-100/LS-110 at the subject and turn the focusing ring until the subject appears sharp.

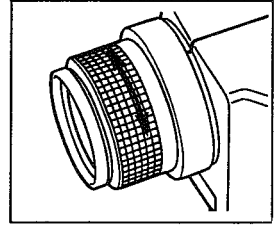

4. Pull the measuring trigger and hold it in until the percent luminance value appears in the viewfinder display (approximately 2 seconds at **FAST** response speed or 4 seconds at **SLOW** response speed). The percent luminance value will also be shown in the external display.

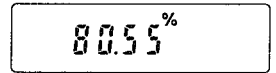
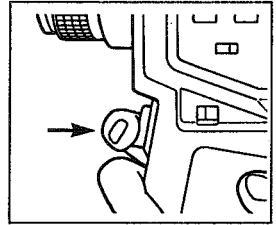

PEAK MEASUREMENTS

The LS-100/LS-110 can be set to display the peak measurement taken during the time that the measuring trigger was held in. To set the meter to peak mode:

1. Slide power switch to **ON**.

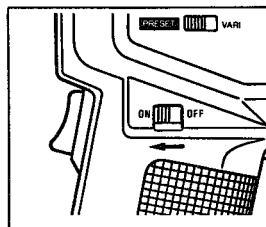

2. Press and hold **F** and press **P/C** to set meter to peak mode; the display at right will appear.

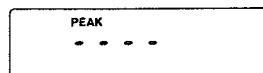
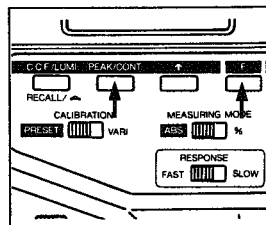

When both keys are released, the display will show "CAL" for a few seconds and then will revert to the measurement display.

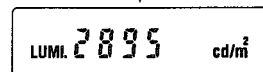
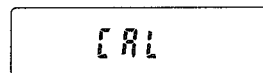

Peak measurements may now be taken in **ABS.** or **%** measuring modes, in **PRESET** or **VARI.** calibration, and with or without a color-correction factor by following the measuring procedure given in the appropriate section of this manual.

COLOR-CORRECTION FACTOR

A color-correction factor can be used by the LS-100/LS-110 to adjust the spectral response of the meter to more accurately measure subjects with colors greatly different than the calibration standard, or when using close-up lenses (page 32). Color-correction factors are normally determined based on measurements using a spectrophotometer. A list of approximate color-correction factors for some common light sources is given on page 30. The meter can store a color-correction factor in memory, and can then calculate measurements based on that factor.

Setting color-correction factor

The color-correction factor can be set between 0.001 and 9.999. To set the color-correction factor, follow the steps below.

1. Slide power switch to **ON**.

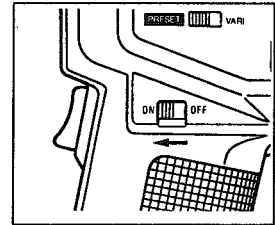

2. Set **CALIBRATION** selector switch to **VARI.** and **MEASURING MODE** to **ABS.**

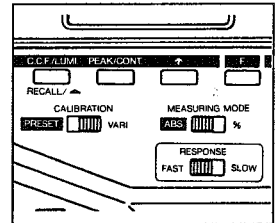

3. Press and hold **F** and press **RCL** repeatedly until the display at right appears.

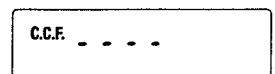
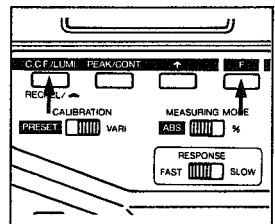

When both keys are released, the display will show "CAL" for a few seconds, and then change to the lower display at right.

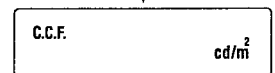
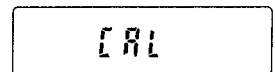

4. Press **RCL/Δ**. The previously set color-correction factor will appear in the display. If no color-correction factor was previously set, the display will show "1.000"

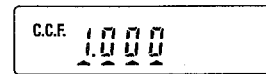
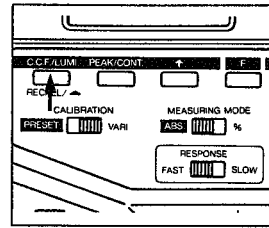

5. Press **RCL/Δ** again. The cursor will appear under only the first digit (from left) of the color-correction factor, as shown at right.

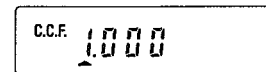
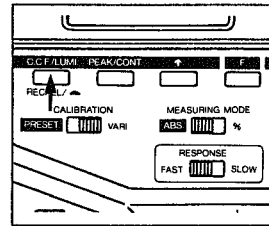

6. Set value of first digit of color-correction factor by pressing and holding **F** and pressing **↑**. The value of digit can be set between 0 and 9. The value is increased by one each time **↑** is pressed while **F** held down; increases continuously if both keys held down. When the value reaches 9, it will return to 0 if **↑** pressed while **F** held down.

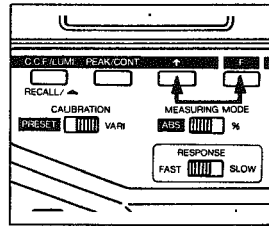

7. Press **RCL/Δ** again. The cursor will move one digit to the right.

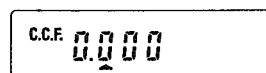
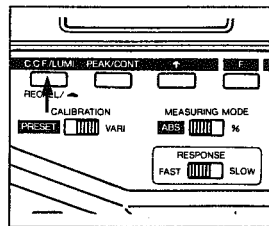

8. Set value of digit by pressing and holding **F** and pressing **↑**

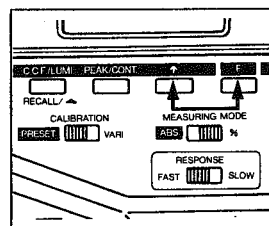

9. Repeat steps 7 and 8 to set third digit, and again to set fourth digit of color-correction factor.
10. To store the color-correction factor in memory, press and hold **F** and slide the CALIBRATION selector switch from **VARI.** to **PRESET** and back to **VARI.** The display will read "CAL" for a moment as the value is stored in memory, and then will revert to a measurement display.

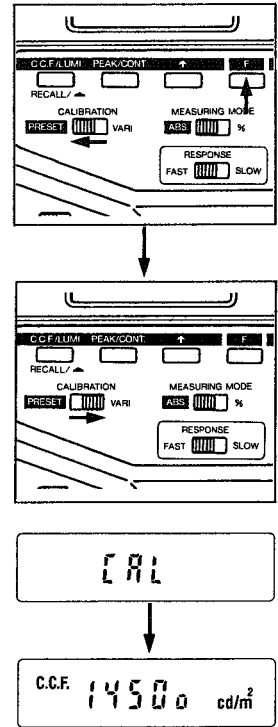

The LS-100/LS-110 is now ready to take measurements using the color-correction factor.

Color-correction factor recall

To check the color-correction factor in memory:

1. Slide power switch to **ON**.

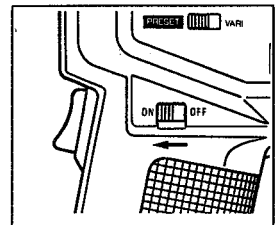

2. Set CALIBRATION selector switch to **VARI.** and MEASURING MODE to **ABS**.

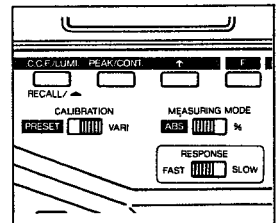

3. Press and hold **F** and press **RCL**, repeatedly until the display at right appears.

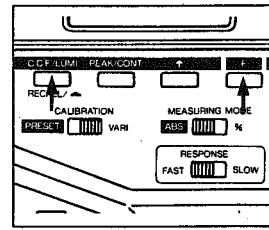

When both keys are released, the display will show "CAL" for a few seconds, and then change to the lower display at right.

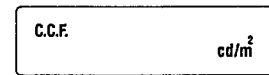
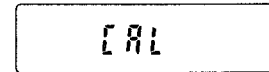

4. Press **RCL**. The previously set color-correction factor will appear in the display. Cursors will appear under all four digits.

Recall display can be canceled by pressing measuring trigger or any of the operation keys, by changing the position of MEASURING MODE or CALIBRATION selector switch, or by sliding the POWER switch to OFF.

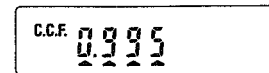
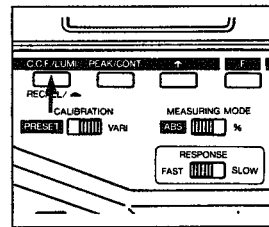

Approximate color-correction factors of common light sources

ILLUMINANT:

CIE Standard Illuminant B
CIE Standard Illuminant C
CIE Standard Illuminant D ₆₅
Daylight fluorescent lamp (F5)
White fluorescent lamp (F6)
Three-band fluorescent lamp*
High-pressure mercury lamp*
High-pressure sodium lamp*
Metal halide lamp (3-additive)*
Metal halide lamp (rare-earth)*
Fluorescent display (Material: ZnO;Zn)*
Color CRT-red*
Color CRT-green*
Color CRT-blue*
Color CRT-white*
CIE Standard Illuminant A + Y-44
CIE Standard Illuminant A + O-54
CIE Standard Illuminant A + R-64

COLOR-CORRECTION FACTOR:

1.007
1.010
1.011
1.013
1.008
1.005
1.007
1.009
1.014
1.009
1.022
0.995
1.018
1.123
1.023
1.000
0.987
0.856

* Color-correction factor calculated based on figure 1 of CIE publication 53: "Detectors".

Measurements using the color-correction factor

Measurements using the color-correction factor can be taken only with the CALIBRATION selector switch set to **VARI**. Both continuous and peak measurements may be taken by following the procedure in the appropriate section of this manual.

Although the CALIBRATION selector switch must be set to the **VARI** position when using the color-correction factor, measurements based on either **PRESET** or **VARI** calibration can be taken.

The mode can be changed by pressing and holding **F** and pressing **RCL**. Mode changes in the following order:

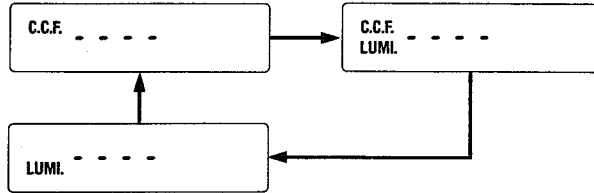

When only "C.C.F." appears in the display, measurements using the color-correction factor will be taken based on **PRESET** calibration.

When both "C.C.F." and "LUMI." appear in the display, measurements using the color-correction factor will be taken based on **VARI** calibration.

When only "LUMI" appears in the display, measurements are taken based on **VARI** calibration, but do not use the color-correction factor.

USING CLOSE-UP LENSES

Optional close-up lenses may be attached to the LS-100/LS-110 for taking measurements of small subjects or at short distances. With no close-up lens, the LS-100/LS-110 can measure subjects as close as 1014mm from the focal-plane indication, with a minimum measuring area of 14.4mm in diameter. By using one of the optional close-up lenses, measurements may be taken down to 205mm from the focal-plane indication, with a measuring area of only 1.3mm in diameter. Only one close-up lens at a time may be attached to the LS-100/LS-110. Further details are shown in the chart below.

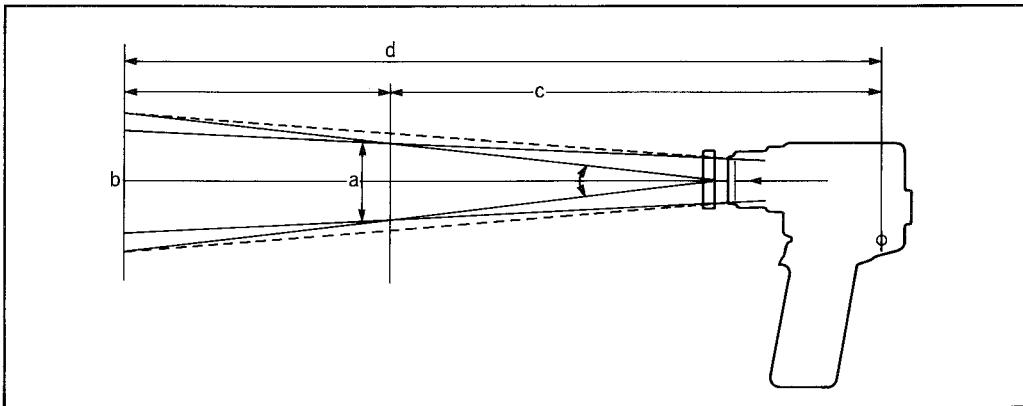

LS-100

Close-up lens	mm	(a) Measuring diameter at minimum measuring distance	(b) Measuring diameter at maximum measuring distance	(c) Minimum measuring distance	(d) Maximum measuring distance
None		φ14.4	—	1014	∞
No.153		φ8.0	φ18.7	623	1210
No.135		φ5.2	φ8.7	447	615
No.122		φ3.2	φ4.3	323	368
No.110		φ1.3	φ1.5	203	205

LS-110

Close-up lens	mm	(a) Measuring diameter at minimum measuring distance	(b) Measuring diameter at maximum measuring distance	(c) Minimum measuring distance	(d) Maximum measuring distance
None		φ4.8	—	1014	∞
No.153		φ2.7	φ6.3	623	1210
No.135		φ1.8	φ2.9	447	615
No.122		φ1.1	φ1.5	323	368
No.110		φ0.4	φ0.5	203	205

When taking measurements with close-up lenses, the response of the meter must be adjusted slightly to compensate for the close-up lens. To do this, set the color-correction factor to 1.050 by following the procedure in the preceding **COLOR-CORRECTION FACTOR** section.

MEMORY

User's calibration data, reference luminance data, and color-correction factor are retained in memory until changed or cleared by the user. Data remains in memory even when the power is switched **OFF**, the battery is replaced, or the power cord is disconnected during use with an external power source.

Memory error

If a memory malfunction occurs and the stored user's calibration data, reference luminance data, or color-correction factor are lost, "E1" will be indicated in the display as shown.

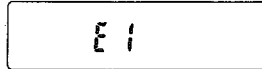

If this display appears, measurements cannot be taken and the memory must be cleared before continuing, according to the procedure in the **Clearing memory** section below.

Memory error may occur if the power is switched off while "CAL" is displayed when converting measured values to measurements in another mode or storing the user's calibration data, reference luminance data, or color-correction factor.

Clearing memory

Follow the procedure below to clear the memory and delete current user's calibration data, reference luminance data, and color-correction factor. If a memory error has occurred, start with step 2.

1. Press and hold both **P/C** and **↑** while sliding the power switch from **OFF** to **ON**. "CLE" will appear in the display.

* If it is decided not to clear the memory, either press the measuring trigger or slide the power switch to **OFF** to cancel the clear procedure.

2. While pressing **F**, slide the CALIBRATION selector switch from **PRESET** to **VARI**. The display will read "CAL" for a moment while the memory is cleared, and then will revert to the measurement display.

All values of user's calibration data and reference luminance data will be set to 0 and the color-correction factor will be set to 1.000. Measurements taken at **PRESET** and **VARI** calibration settings will be equal, as will measurements taken with and without the color-correction factor.

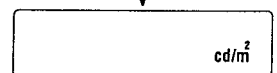
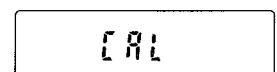
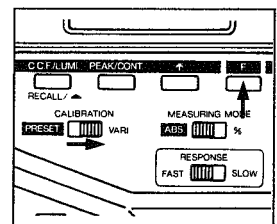
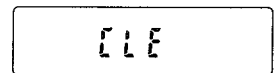
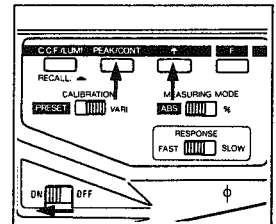

LOCKING THE FOCUSING RING

The focusing ring can be locked to prevent the focus from shifting, such as when the LS-100/LS-110 is set up for taking several measurements without refocusing.

To lock the focusing ring, insert an M3 screw (at least 5mm long) into the focusing ring lock hole and tighten until snug. Do not overtighten.

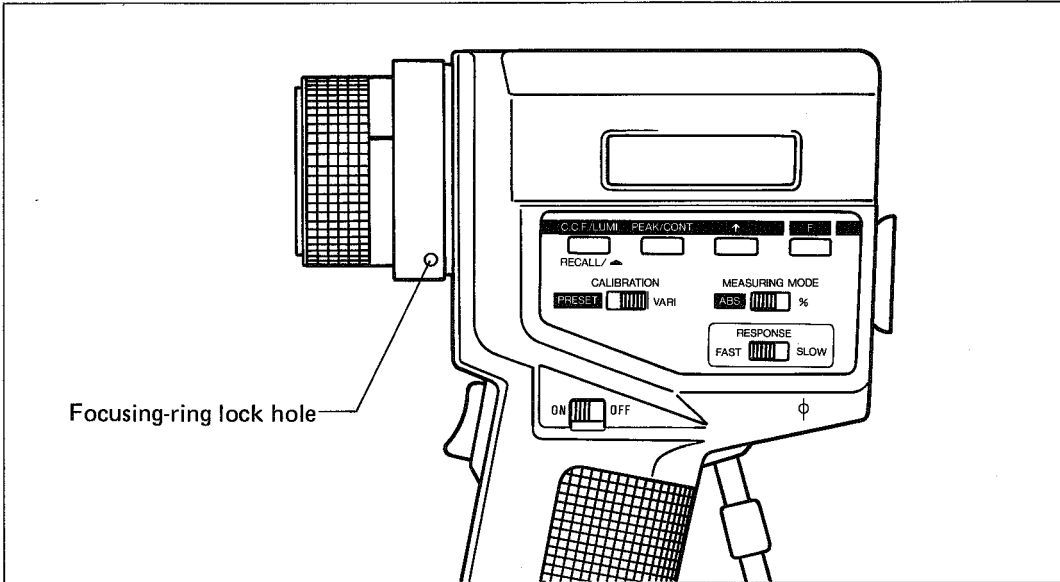

MEASURING SYSTEM

Optical system

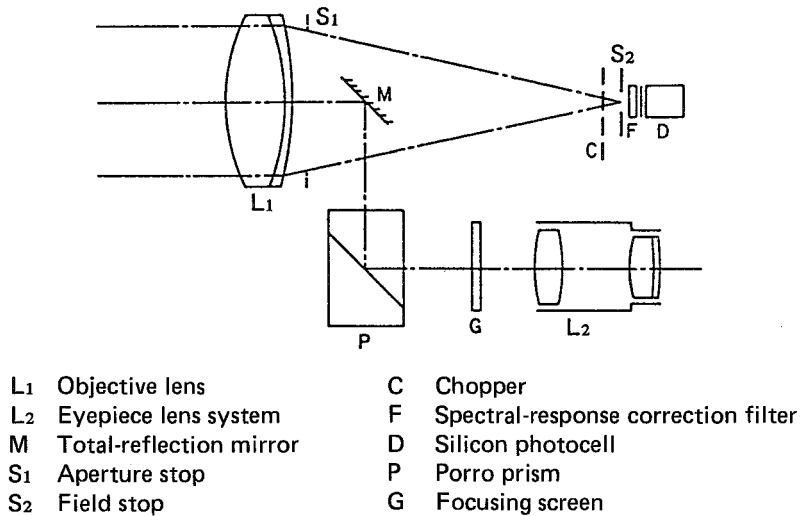

The optical system of the LS-100/LS-110 is shown in the above diagram. Light from the subject enters the objective lens (L) and passes through the aperture stop (S₁). A small portion of this light is reflected downward by the total-reflection mirror (M), while the main portion of the light continues on. This main portion passes through the chopper (C), the field stop (S₂), and the spectral-response correction filter (F), and strikes the silicon photocell (D), which converts the light to an analog electrical current. The spectral response of the photocell is filtered to closely match the CIE (Commission Internationale de l'Eclairage) Relative Photopic Luminosity Response, as shown below.

SPECTRAL RESPONSE

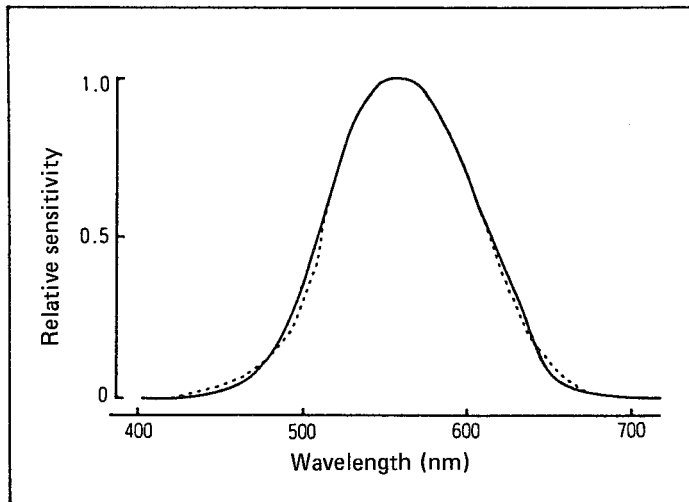

— Spectral response of Minolta Luminance Meters LS-100/LS-110
 - - - CIE Relative Photopic Luminosity Response

The light which was reflected downward enters a Porro prism, and is directed onto the focusing screen to form the viewfinder image. The measurement area is accurately indicated on the focusing screen, and the viewfinder display allows the subject and the measured luminance to be seen at the same time.

Electronic system

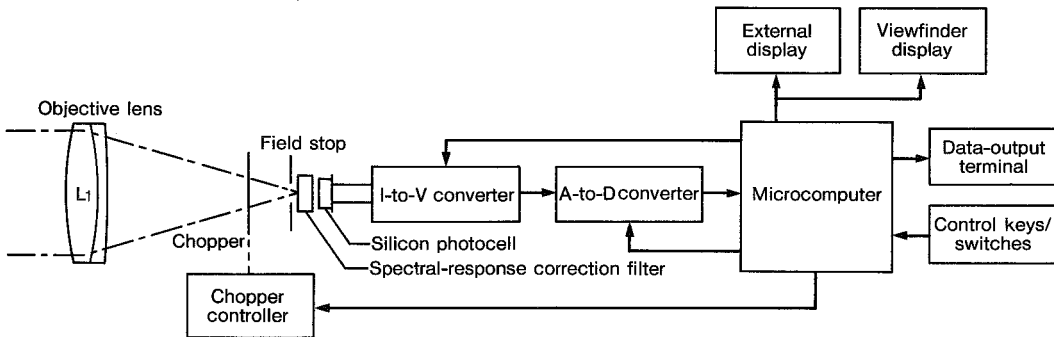

After the light has been converted to an analog electrical current by the silicon photocell, this current is converted to a proportional voltage by a current-to-voltage (I/V) converter. This voltage signal then enters an analog-to-digital (A/D) converter, where it is changed to a digital signal. The digital signal is used by the built-in microcomputer of the LS-100/LS-110, which determines the data to be displayed on the external and viewfinder displays according to the measurement conditions set by the user with the control keys and switches. These measurement conditions include calibration standard, absolute or percent measurement mode, response speed, continuous or peak mode, and whether or not the color-correction factor should be included in the calculations.

Influence of flare

As shown in the diagram below, light sources outside the angle of acceptance of the LS-100/LS-110 influence measurements only slightly. When a point source moves from point A (inside the meter's angle of acceptance) to point B (outside the angle of acceptance), its measured value at B is less than 0.1 percent of its measured value at A.

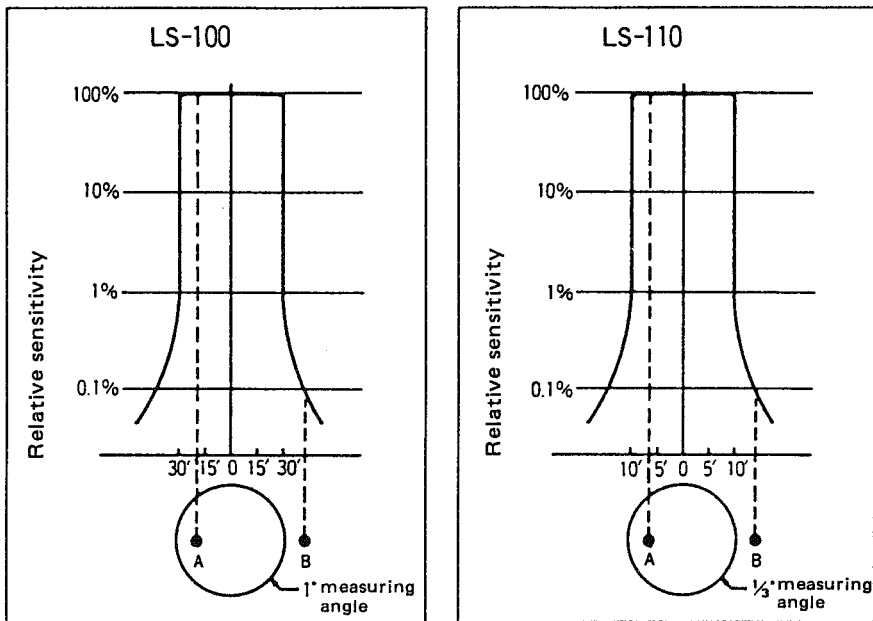

KONICA MINOLTA STANDARD CALIBRATION PROCEDURE

The CALIBRATION selector switch of the LS-100/LS-110 can be set to the **PRESET** position for taking measurements based on Factory standard calibration. This calibration is adjusted at the factory before shipping according to the following procedure.

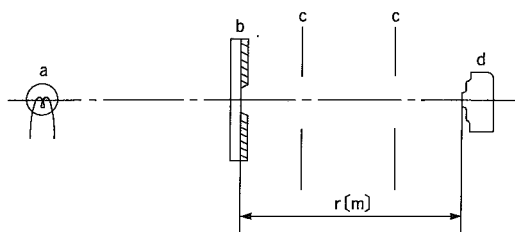

- a Luminous intensity standard lamp calibrated by the Electro Technical Laboratory of the Japanese Ministry of International Trade and Industry
- b White transmitting diffuser plate attached to a plate with an aperture of known area
- c Series of baffles to insure that the influence of flare is reduced to a minimum
- d Meter position

1. A previously calibrated illuminance meter is placed at the meter position and a measurement of the illuminance at this point is taken.
2. This illuminance measurement is used to calculate the luminance at the same position according to the formula:

$$L = \frac{(E \times r^2)}{A}$$

- 3 The LS-100/LS-110 to be calibrated is placed at the meter position and adjusted until the luminance in the display is equal to the value of L calculated from the above equation.

CARE AND STORAGE

- Do not touch the front lens surface. If it becomes dirty, remove any loose dust with a blower or compressed air, and wipe lightly with lens tissue if necessary. For safety, cover lens with the lens cap when not using meter.
- When dirty, the meter may be wiped with a silicone-treated cloth or other clean, dry cloth. Do not allow alcohol or chemicals to touch the meter's surface.
- If the meter is used at temperatures higher than 40°C (104°F) or less than 0°C (32°F), operation may be unsatisfactory.
- Do not leave the meter in places subject to high humidity or to temperatures higher than 55°C (131°F) or lower than -20°C (-4°F).
- Do not leave the meter inside a closed motor vehicle, in direct sunlight, or near sources of heat, such as stoves, strong lights, etc.
- Never look through the viewfinder and aim the meter at the sun. Doing so may damage your eyes and the meter's photocell.
- Do not aim the lens at the sun at any time, even during transportation or storage. For safety, cover lens with the lens cap when not using the meter.
- Do not subject the meter to shock or vibration.
- Do not press on the liquid-crystal display window.
- Never attempt to disassemble the meter. Any necessary repairs should be done only by an authorized Minolta service technician.
- When the meter is to be stored for an extended period of time, remove the battery, place the meter in its original packaging, and put it in an airtight container with a dehumidifying agent, such as silica gel.

SPECIFICATIONS

- Type: Spot luminance meter
- Receptor: Silicon photocell filtered to closely match the CIE Relative Photopic Luminosity Response
- Calibration: PRESET for Minolta standard calibration
VARI. for user-selected calibration standard
- Measuring modes: ABS. for measuring absolute luminance
% for determining percent luminance in relation to a reference luminance in memory
- Other measuring functions: PEAK function to display highest value of absolute or percent luminance measured while measuring trigger held in; C.C.F. (color-correction factor) to correct meter response when measuring colored subjects or using close-up lenses
- Optical system: 85mm f/2.8 lens; TTL (through-the-lens) viewing system; influence of flare on measurement less than 1.5%
- Acceptance angle: LS-100: 1°
LS-110: 1/3°
- Field of view: 9° (with circular measurement-area indication)
- Focusing distance: 1014mm to infinity (205mm minimum using close-up lens)
- Minimum target area: LS-100: ϕ 14.4mm at 1014mm (ϕ 1.3mm at 205mm using close-up lens)
LS-110: ϕ 4.8mm at 1014mm (ϕ 0.4mm at 203mm using close-up lens)
- Luminance units: cd/m² or fL selectable; calibration and reference luminance values in memory automatically converted
- Measuring range: LS-100: FAST: 0.001 to 299900 cd/m² (0.001 to 87530 fL)
SLOW: 0.001 to 49990 cd/m² (0.001 to 14590 fL)
LS-110: FAST: 0.01 to 999900 cd/m² (0.01 to 191800 fL)
SLOW: 0.01 to 499900 cd/m² (0.01 to 145900 fL)
- Accuracy: LS-100: 0.001 to 0.999 cd/m² (or fL): \pm 2% \pm 2 digits of measured value
1.000 cd/m² (or fL) or more: \pm 2% \pm 1 digit of measured value
LS-110: 0.01 to 9.99 cd/m² (or fL): \pm 2% \pm 2 digits of measured value
10.00 cd/m² (or fL) or more: \pm 2% \pm 1 digit of measured value
(Measuring conditions: Subject: Standard Illuminant A; ambient temperature: 20 to 30°C/68 to 86°F)
- Short-term repeatability: LS-100: 0.001 to 0.999 cd/m² (or fL): \pm 0.2% \pm 2 digits of measured value
1.000 cd/m² (or fL) or more: \pm 0.2% \pm 1 digit of measured value
LS-110: 0.01 to 9.99 cd/m² (or fL): \pm 0.2% \pm 2 digits of measured value
10.00 cd/m² (or fL) or more: \pm 0.2% \pm 1 digit of measured value
(Measuring subject: Standard Illuminant A)
- Displays: External LCD panel shows measured value plus operation and error indications; viewfinder LCD panel shows measured value
- Data output: 1-bit serial, ASCII code, \pm 5V, 4800 baud; output via Hirose RP17-13RA-12SD connector; remote control possible

- Power source:** One 9V battery (Eveready 216 or equivalent); external power supply may be used via data-output terminal
- Operating temperature range:** 0 to 40°C (32 to 104°F) relative humidity less than 85% at 35°C with no condensation
- Storage temperature range:** -20 to +55°C (-4 to +131°F) with no condensation
- Dimensions:** 208 x 79 x 150mm (8-3/16 x 3-1/8 x 5-7/8 in.)
- Weighth:** 850g (30 oz.) without battery
- Standard accessories:** Lens cap, eyepiece cap, ND eyepiece filter, data-output terminal cover, 9V battery, case
- Optional accessories:** Close-up lenses, data printer, long eye-relief eyepiece

Specifications subject to change without notice



KONICA MINOLTA